

LP SERIES-General Purpose

LP12-90 (12V90AH)

Specification

Nominal Voltage	12V	
Nominal Capacity(10HR)	90.0AH	
Dimensions	Length	330±3mm (12.99 inches)
	Width	173±2mm (6.81 inches)
	Container Height	212±3mm (8.35 inches)
	Total Height (with Terminal)	220±3mm (8.66 inches)
Approx Weight	Approx 28.0 kg (61.7lbs)	
Terminal	T11	
Container Material	ABS	
Rated Capacity	93.6 AH/4.68A	(20hr, 1.80V/cell, 25°C/77°F)
	90.0AH/9.0A	(10hr, 1.80V/cell, 25°C/77°F)
	77.5 AH/15.5A	(5hr, 1.75V/cell, 25°C/77°F)
	70.2AH/23.4A	(3hr, 1.75V/cell, 25°C/77°F)
	54.9 AH/54.9A	(1hr, 1.60V/cell, 25°C/77°F)
Max. Discharge Current	1080A (5s)	
Internal Resistance	Approx 5.0mΩ	
Operating Temp. Range	Discharge	-15~50°C (5~122°F)
	Charge	0~40°C (32~104°F)
	Storage	-15~40°C (5~104°F)
Nominal Operating Temp. Range	25±3°C (77±5°F)	
Cycle Use	Initial Charging Current less than 27.0A. Voltage	
	14.4V~15.0V at 25°C(77°F) Temp. Coefficient -30mV/°C	
Standby Use	No limit on Initial Charging Current Voltage	
	13.5V~13.8V at 25°C(77°F) Temp. Coefficient -20mV/°C	
Capacity affected by Temperature	40°C (104°F)	103%
	25°C (77°F)	100%
	0°C (32°F)	86%
Self Discharge	Leoch LP series batteries may be stored for up to 6 months at 25°C(77°F) and then a freshening charge is required. For higher temperatures the time interval will be shorter.	



Applications

- ◆ All purpose
- ◆ Uninterruptable Power Supply (UPS)
- ◆ Electric Power System (EPS)
- ◆ Emergency backup power supply
- ◆ Emergency light
- ◆ Railway signal
- ◆ Aircraft signal
- ◆ Alarm and security system
- ◆ Electronic apparatus and equipment
- ◆ Communication power supply
- ◆ DC power supply
- ◆ Auto control system



Constant Current Discharge (Amperes) at 25 °C (77°F)

F.V/Time	5min	10min	15min	20min	30min	45min	1h	2h	3h	4h	5h	6h	8h	10h	20h
1.85V/cell	154.0	121.1	103.0	86.1	68.5	51.8	42.4	27.0	21.4	17.5	14.1	12.2	9.95	8.50	4.64
1.80V/cell	206.8	154.7	124.4	101.8	80.8	60.3	47.5	29.5	23.0	18.6	15.1	13.1	10.5	9.00	4.68
1.75V/cell	233.1	170.0	135.9	109.5	83.9	62.5	49.7	30.6	23.4	19.1	15.5	13.5	10.7	9.09	4.73
1.70V/cell	256.7	185.3	145.1	115.1	87.3	65.0	51.3	31.8	24.1	19.6	15.9	13.8	10.9	9.18	4.82
1.65V/cell	283.1	200.0	154.3	122.3	92.1	66.7	53.0	32.7	25.1	20.2	16.3	14.1	11.1	9.37	4.88
1.60V/cell	312.2	217.1	165.0	130.3	97.2	69.5	54.9	33.8	25.9	20.9	16.9	14.4	11.2	9.47	4.91

Constant Power Discharge (Watts/cell) at 25 °C (77°F)

F.V/Time	5min	10min	15min	20min	30min	45min	1h	2h	3h	4h	5h	6h	8h	10h	20h
1.85V/cell	281.6	223.7	192.2	162.4	130.5	99.6	81.8	52.5	41.6	34.1	27.6	24.1	19.6	16.8	9.18
1.80V/cell	374.0	282.5	229.1	189.1	151.6	114.9	91.2	56.9	44.6	36.2	29.5	25.7	20.8	17.8	9.26
1.75V/cell	412.7	305.4	247.1	201.5	156.1	118.1	95.0	58.8	45.2	36.9	30.2	26.4	21.1	17.9	9.33
1.70V/cell	441.9	325.3	260.2	210.2	161.6	122.4	97.6	61.0	46.4	37.8	30.9	26.9	21.3	18.1	9.51
1.65V/cell	480.4	347.9	274.5	221.6	169.1	124.3	100.2	62.3	48.1	39.0	31.6	27.4	21.6	18.4	9.62
1.60V/cell	517.6	369.1	288.7	233.5	177.2	128.9	103.2	64.1	49.4	40.1	32.5	27.9	21.8	18.6	9.66

Dimensions

Unit: mm [inches]

Terminal: T11

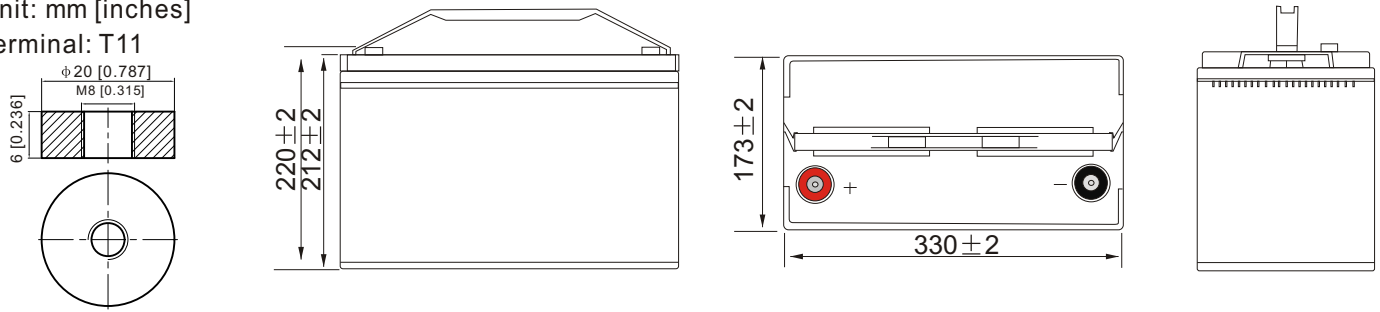

Discharge Characteristics

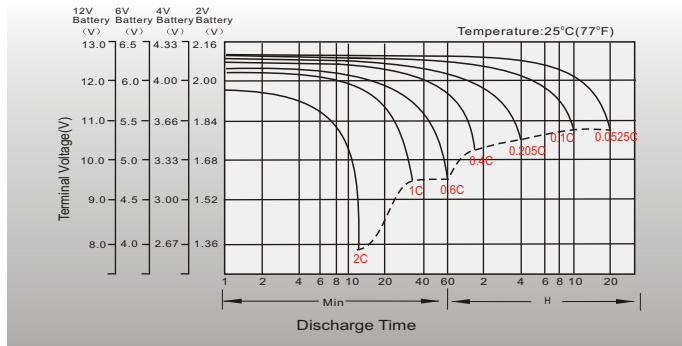

Float Charging Characteristics

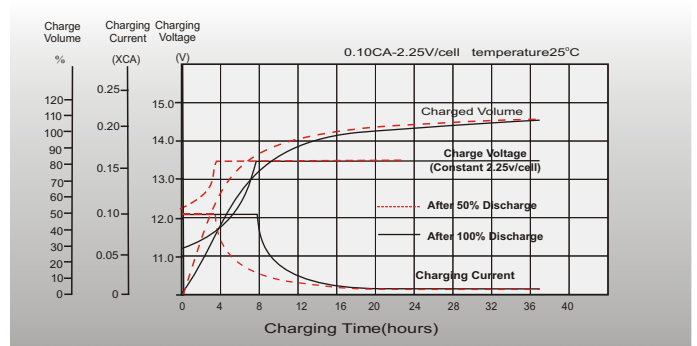

Temperature Effects in Relation to Battery Capacity

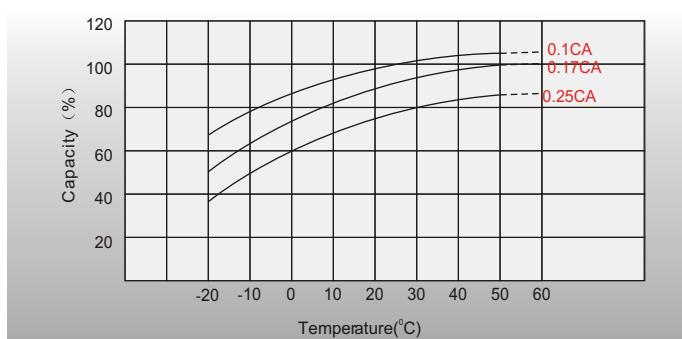

Effect of Temperature on Long Term Float Life

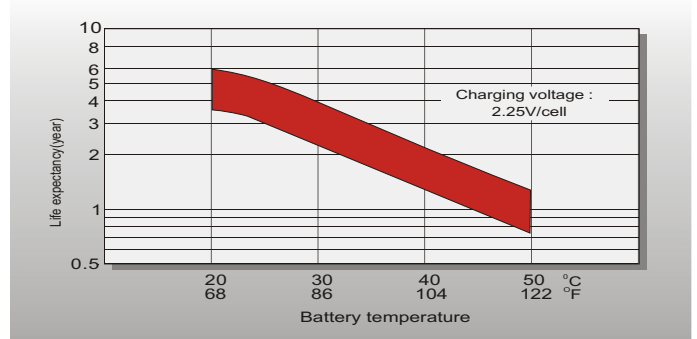

Cycle Life in Relation to Depth of Discharge

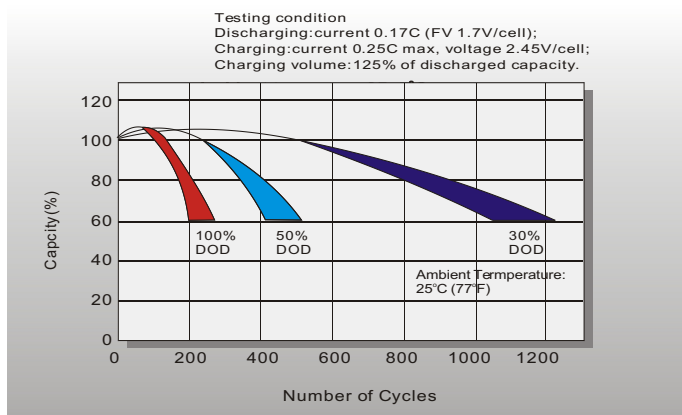

Self Discharge Characteristics

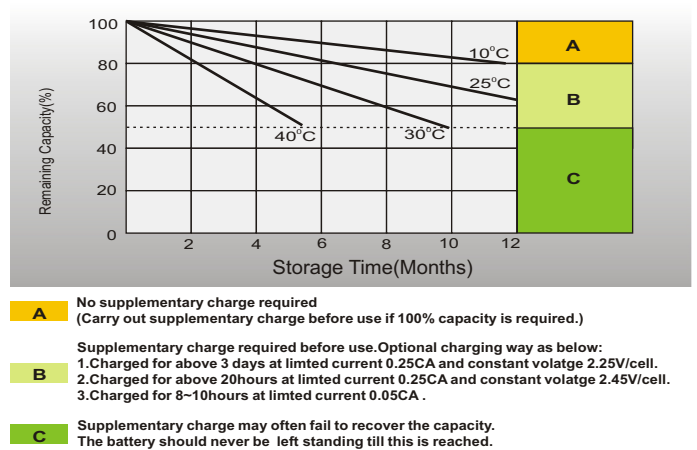

- A** No supplementary charge required (Carry out supplementary charge before use if 100% capacity is required.)
- B** Supplementary charge required before use. Optional charging way as below:
1. Charged for above 3 days at limited current 0.25CA and constant voltage 2.25V/cell.
2. Charged for above 20 hours at limited current 0.25CA and constant voltage 2.45V/cell.
3. Charged for 8-10 hours at limited current 0.05CA.
- C** Supplementary charge may often fail to recover the capacity. The battery should never be left standing till this is reached.

Sales Office

China sales office:

Add: 5th Floor, Xinbaohui Bldg., Nanhai Blvd.,
Nanshan, Shenzhen, China. 518052
Tel: +86-755-86036060 (100 lines)
Fax: +86-755-26067269
E-mail: export@leoch.com
Http://www.leoch.com

North America sales office:

Add: 19751 Descartes, Unit A,
Foothill Ranch, CA 92610, USA
Tel: 949-588-5853
Fax: 949-588-5966
E-mail: sales@leoch.us
Http://www.leoch.us

Europe sales office:

Add: 9B Wheatstone Park, Waterwells
Business Park, Gloucester, GL2 2AQ, UK.
Tel: +44(0) 01452 729428
Fax: +44 (0)1452-690125
E-mail: Sales.Europe@leoch.com

Singapore sales office:

Add: No. 53, Ubi Avenue 1, #03-21 Paya
Ubi Industrial Park, Singapore 408934
Tel: + 65 6841 6629
E-mail: sales.sg@leoch.com

HongKong sales office:

Add: Unit 3910, 39/F, Cable TV Tower, No. 9
Hoi Shing Road, Tsuen Wan, NT, H.K.
Tel: +852 3578 6666
E-mail: sales.hk@leoch.com